

For reference only. See data sheet for the detailed specifications.

Technical Specification

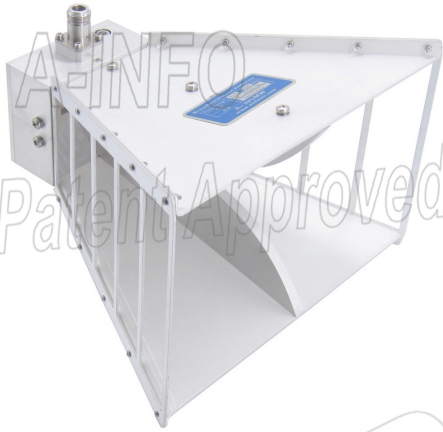

Frequency Range(GHz)	0.8 – 18.0
Gain(dBi)	12 Typ.
Polarization	Linear
3dB Beamwidth(deg)	E Plane: 111 - 13
	H Plane: 78 - 10
Cross Pol. Isolation(dB)	25 Typ.
VSWR	1.5:1 Typ.
Connector	N-Female or SMA-Female
Power Handling(W CW)	N-Female: 300 Max.
	SMA-Female: 50 Max.
Material	Al
Finish	Chemical Conversion Coating
Size(mm)	244 x 160.5 x 228
Net Weight(Kg)	1.50 Around

PATENT ID (China)

ZL201621014310.X, ZL201630454754.4

Outline Drawing (Size: mm)

N-Female Output (P/N: LB-8180-NF)

For SMA-Female output outline drawing, please contact A-INFO.

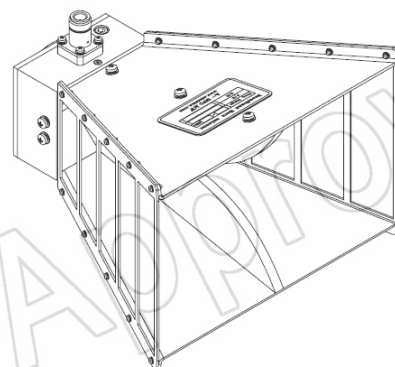
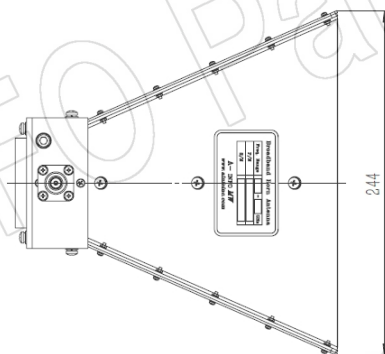
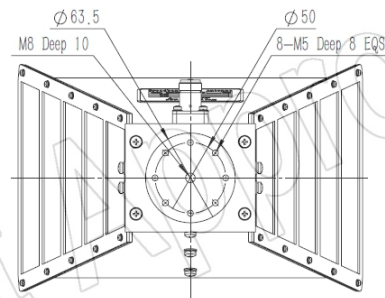
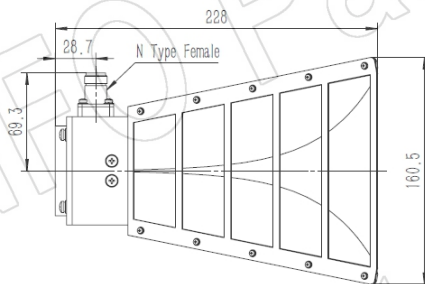

AINFO Inc.

Page 1 of 11

China(Beijing):
China(Chengdu):
USA :

Tel: (+86) 10-6266-7326,
Tel: (+86) 28-8519-2786,
Tel: (+1) 949-639-9688,

(+86) 10-6266-7327
(+86) 28-8519-3044
(+1) 949-639-9608

Fax: (+86) 10-6266-7379
Fax: (+86) 28-8519-3068
Fax: (+1) 949-639-9670

Website: www.ainfoinc.com
Email: sales@ainfoinc.com

N-Female Output with L Type Mounting Bracket (Option, P/N: LB-10180-L)

For SMA-Female output outline drawing, please contact A-INFO.

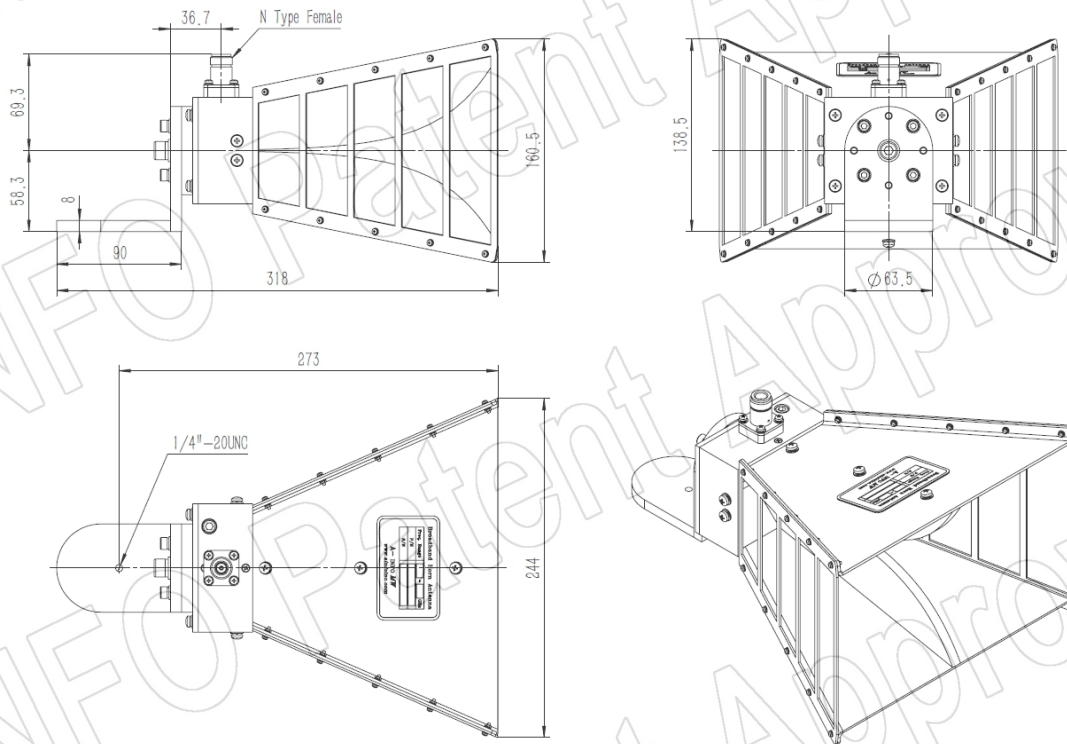

N-Female Output with Radome (Option, P/N: LB-8180-NFSPO, Outdoor Application)

For SMA-Female output outline drawing, please contact A-INFO.

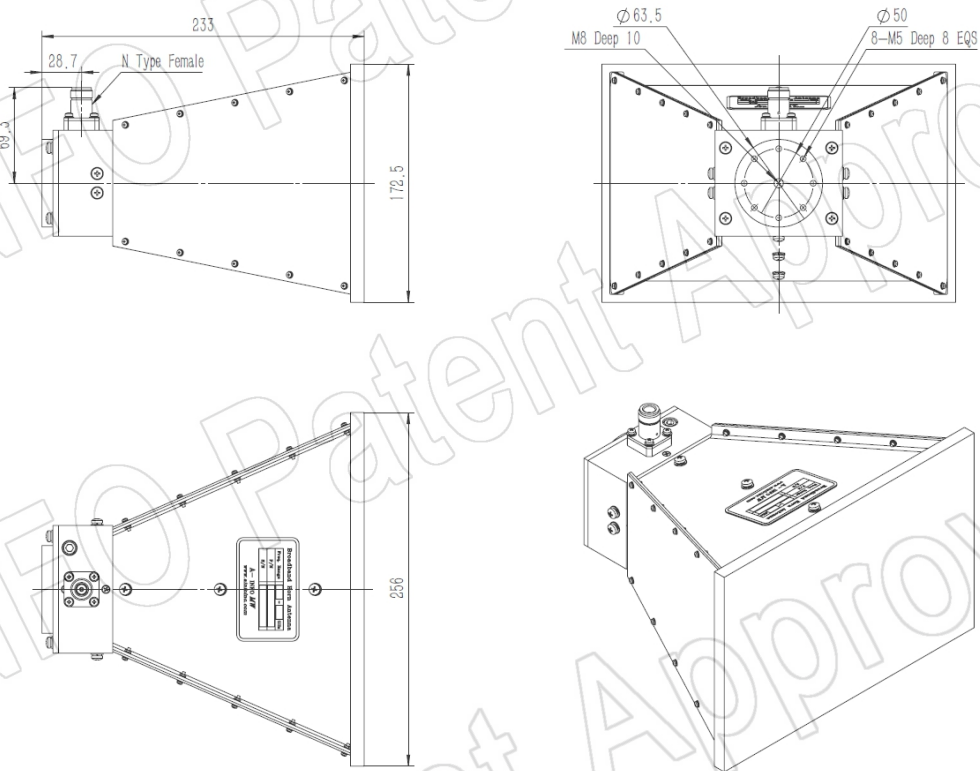

N-Female Output with L Type Mounting Bracket & Radome (Option, P/N: LB-10180-L & LB-8180-NFSPO, Outdoor Application)

For SMA-Female output outline drawing, please contact A-INFO.

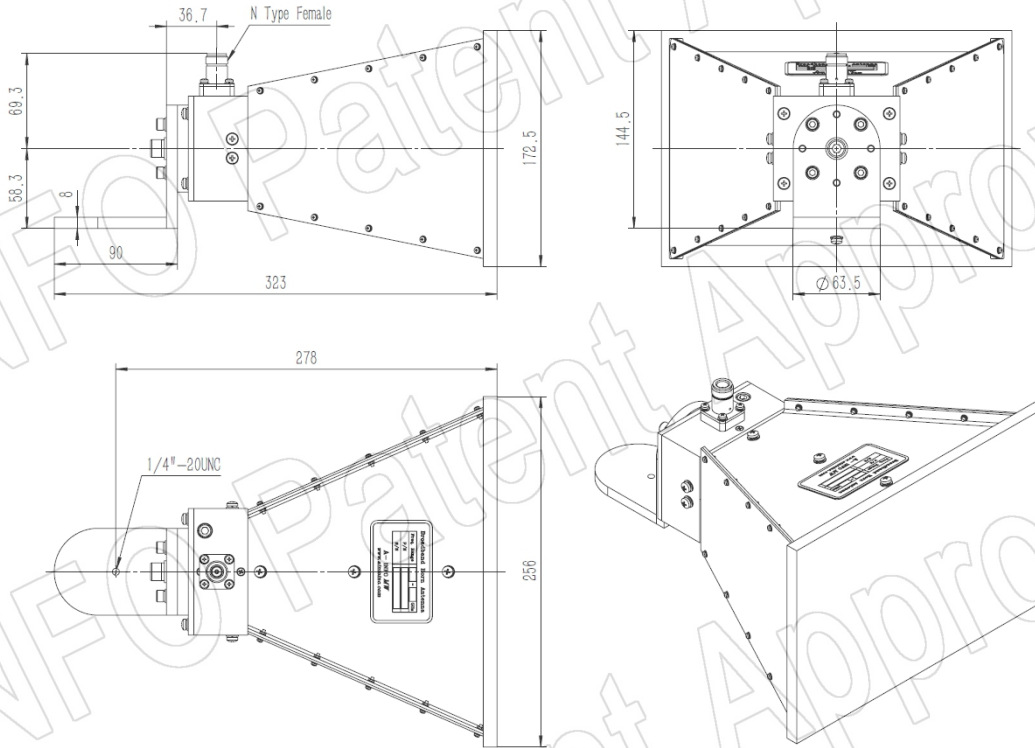

Test Results

1. Gain & Antenna Factor

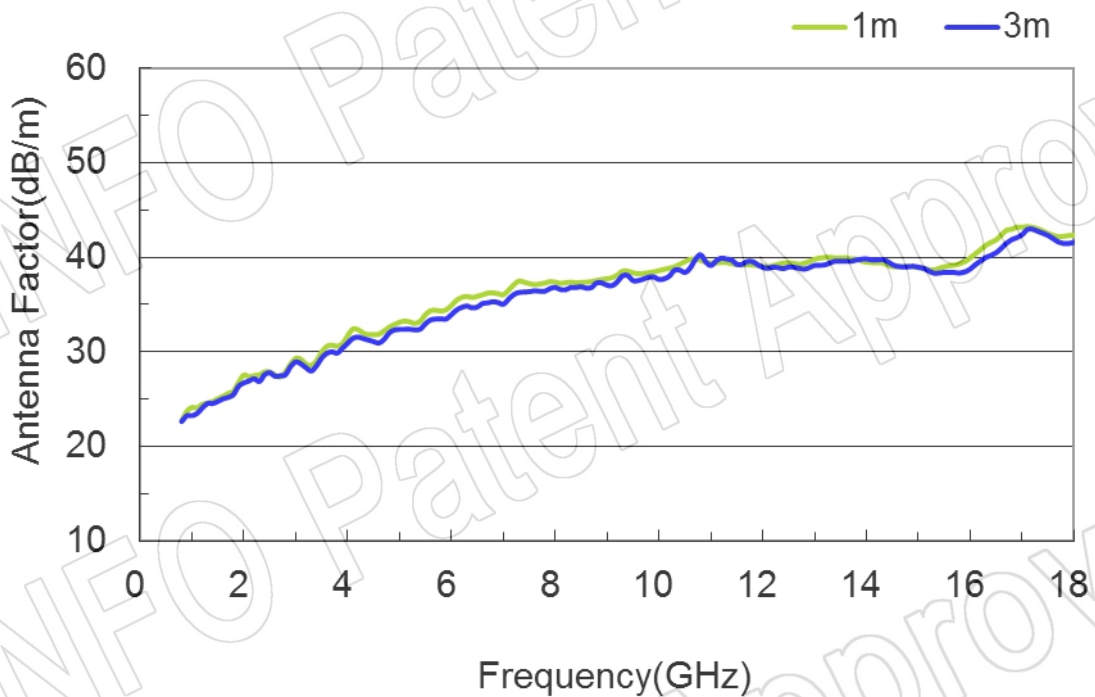
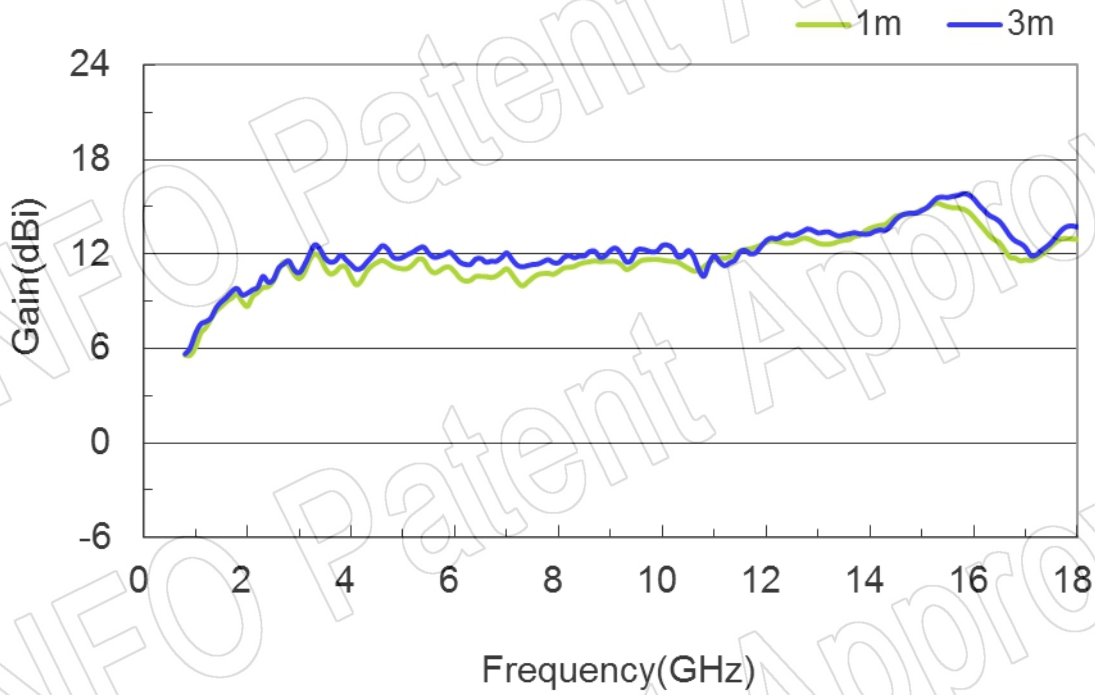

2. Cross Polarization Isolation

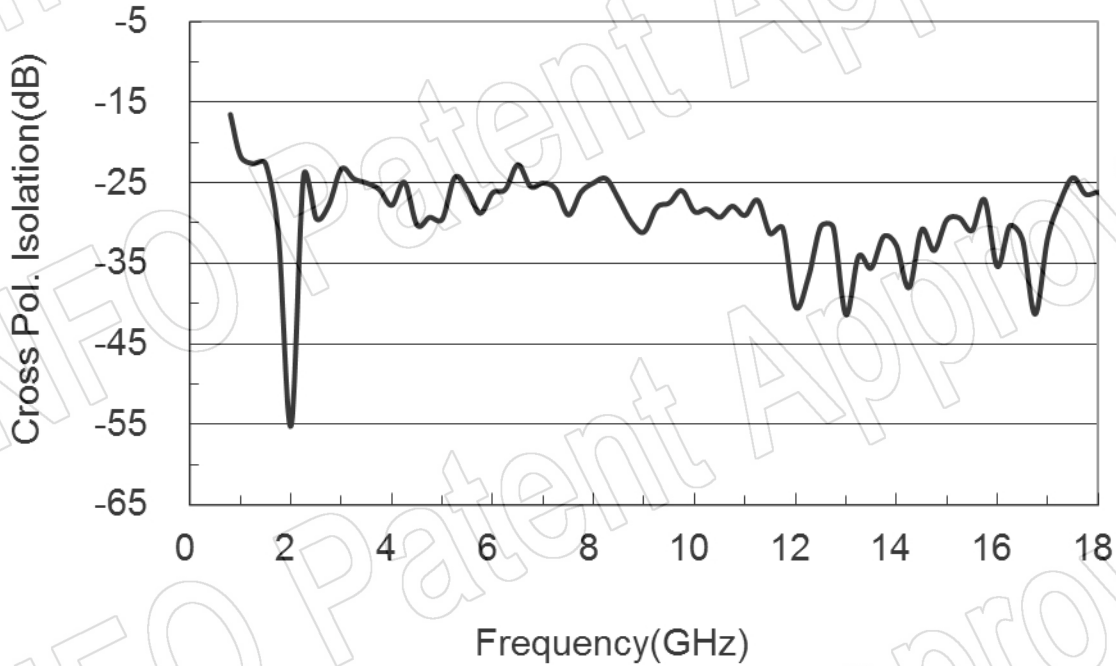

3. VSWR

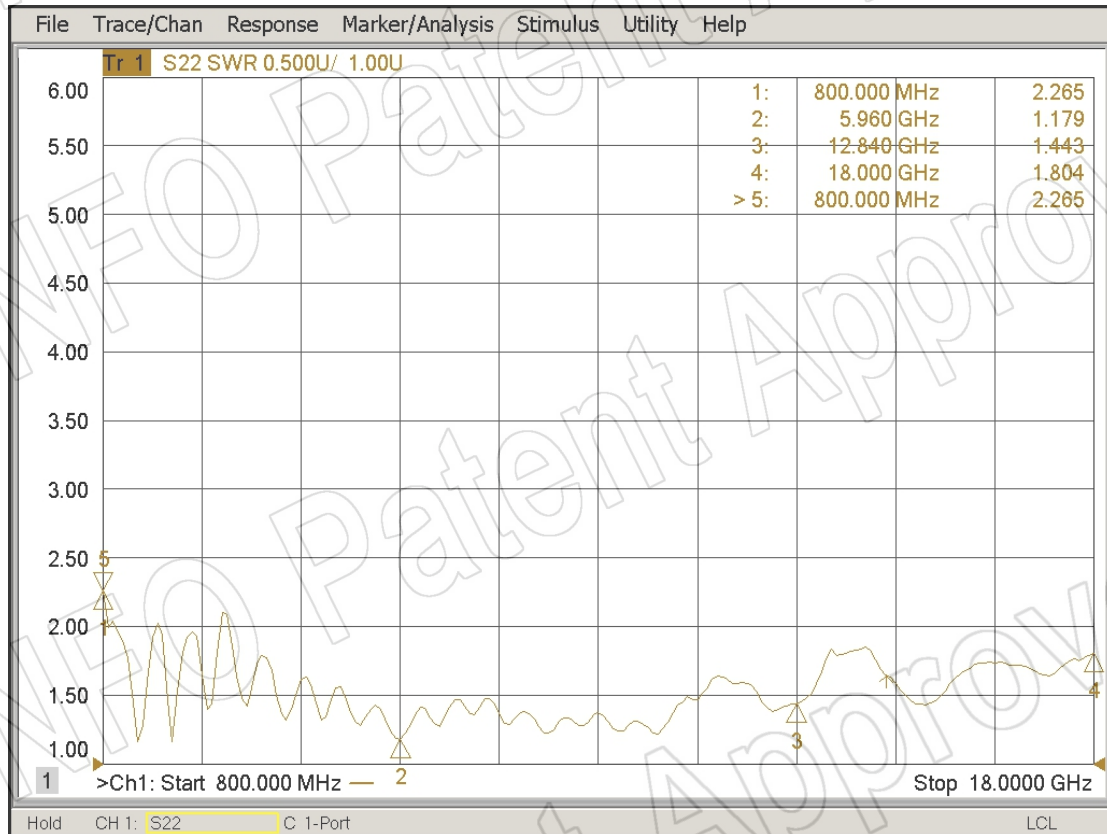

4. Pattern

